

PLEASE WAIT

PLEASE WAIT to be SEATED

Egon Eiermann

to be



SEATED

EGON EIERMANN

Egon Eiermann is one of the most iconic architects of post-war modernism in Germany. You might never have heard of him, as he has always stood a-long side, but always a little in the shadow of, Mies van der Rohe, Le Corbusier and Charles and Ray Eames. He is famous in Germany for his pure modernistic post war architecture, such as the Kaiser Wilhelm Memorial Church in Berlin and the Olivetti Towers in Frankfurt am Main.

One of the reasons why he never made an international break-through, is said to be his absolute focus on detail and lack of compromise, which led the always immaculately dressed Mr. Eiermann, to exceed budgets.

Today his designs have become popular in Germany, many years after his death in 1970. In an interview to Der Spiegel, Eiermann claimed, that his furniture designs were properly designed, primarily for architects, "The average consumer will never be my friend" he concluded.



The West German pavilion at the Brussels World Exhibition 1958 by Egon Eiermann

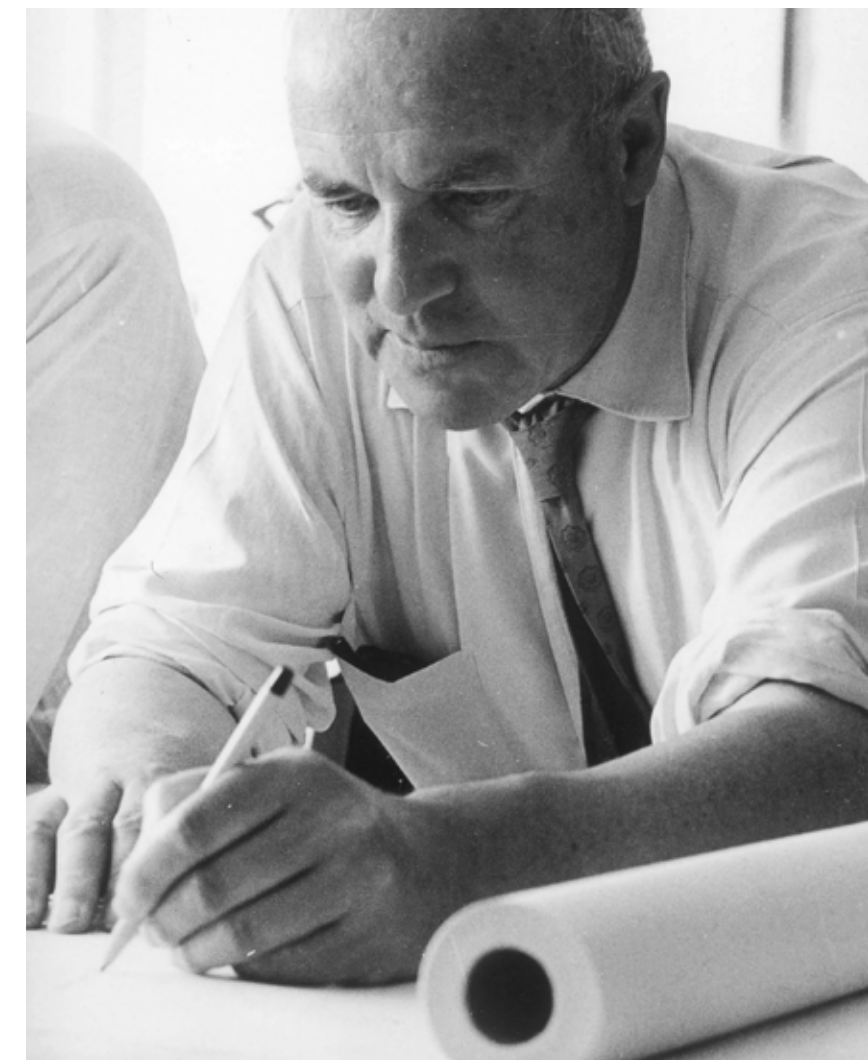

Professor Egon Eiermann



EIERMANN2 Dining table, Navy Blue frame with black linoleum table top · SE68 Dining Chair, blue on black frame · NOUVEAU PIN, Rouge Noir · BLOOPER Lamp · WALL BOX

PLEASE WAIT to be SEATED + EIERMANN

PLEASE WAIT to be SEATED is a contemporary Danish brand, based on the idea of design traditions, though with a slight twist. We admire the aesthetic designs of Egon Eiermann from first sight, and our company is truly built upon this enthusiasm.

We just had to share our enthusiasm with fellow like minded design followers. Wilde + Spieth and Richard Lampert are the respective, manufactures of the Eiermann chairs and the Eiermann tables. Together with the two manufactures, PLEASE WAIT to be SEATED have spread the word about Egon Eiermanns' classic and iconic designs with great success.

In 1951 Mr. Eiermann designed the chair SE68 for a symphony orchestra in southern Germany. Through-out the past 71 years, the SE68 has been one of the most commonly used orchestra chairs in the world. Most recently in the Elbphilharmonie in Hamburg, designed by Herzog & de Meuron. This must truly indicate that the comfort of the SE68 is extraordinary.



Photo: Jens Langhjaer

Baum und Pferdgarten
SE68 Dining Chair with chrome frame

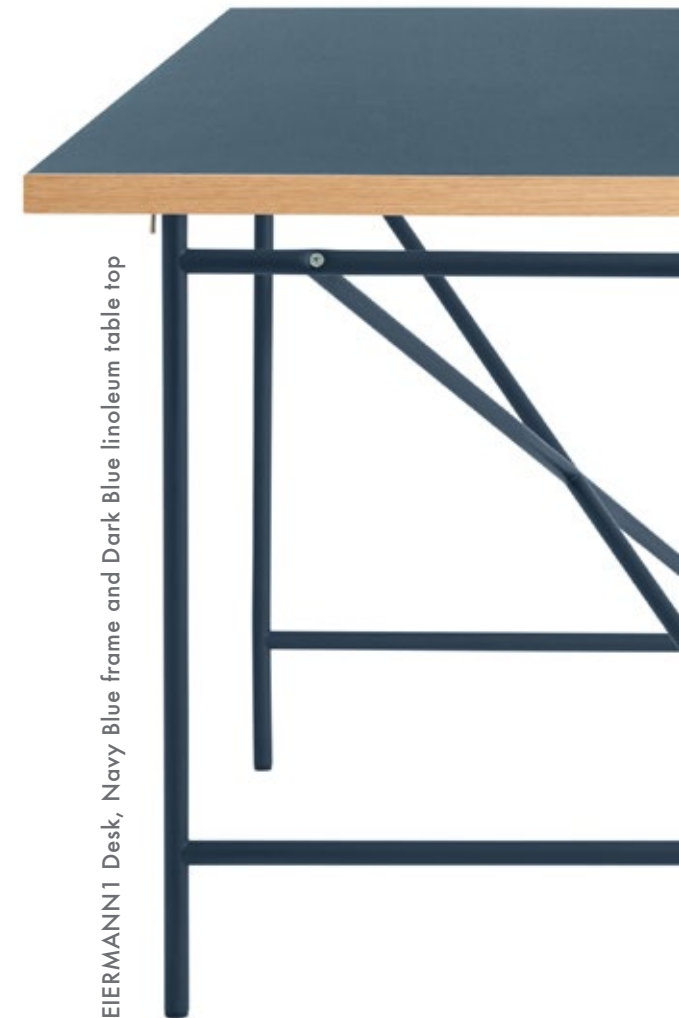

EIERMANN1 Desk, Navy Blue frame and Dark Blue linoleum table top



OVERGAARD & DYRMAN Workshop
 EIERMANN2 Dining table, black frame with black ash table top · SBG197R Office Chair
 TUBBY TUBE Stool · SPADE Chair, natural ash · TOKIO Desk Lamp



PLEASE WAIT to be SEATED Showroom
 EIERMANN1 Desk, Cedar Green frame with dark blue linoleum table top · SBG197R Office Chair · S38 S/1 stool, black frame ·
 WALLBOX, Cedar Green with Navy Blue · BLOOPER Lamp

SBG197R Office Chair





BETA PRIVATE DINING CLUB
SE68 Dining Chair, PWTBS blue with black frame

SE68SU
the stackable
version of SE68

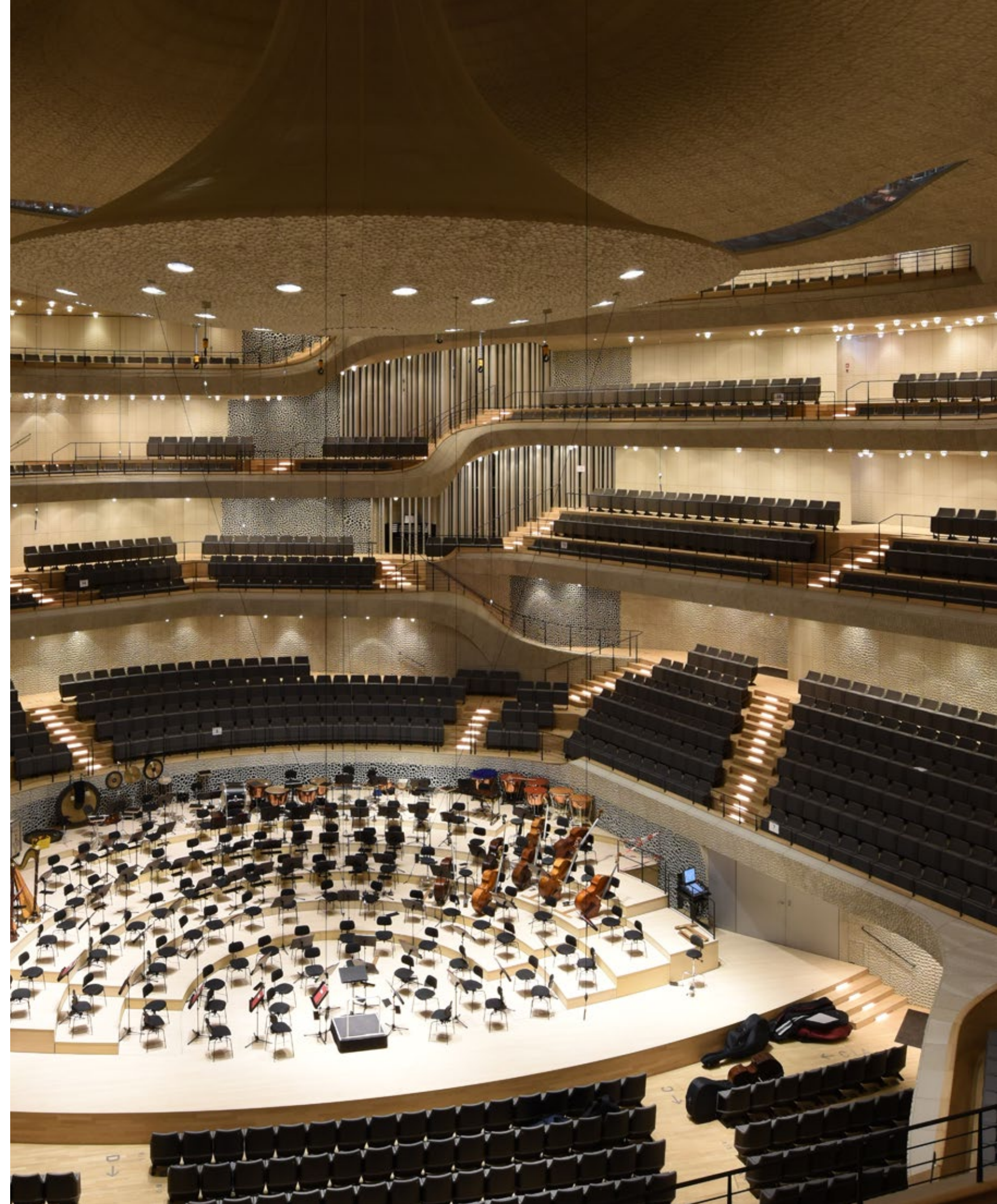

ELBPILHARMONIE IN HAMBURG by Herzog & de Meuron
Eiermann Orchestra chairs

Photo: Fotozapf



PLEASE WAIT to be SEATED Showroom
EIERMANN2 Dining table, black frame with Green linoleum table top · SBG197R Office Chair · HARDIE Low Stool · TOKIO Desk Lamp
KANSO Coffee Table · ANZA Bench Cedar Green · ARQUI RUG1 · NOUVEAU PIN, Navy Blue with brass frame



SE68 Dining Chair,
PWTBS Dark Green with black frame



SE68 Dining Chair,
PWTBS Navy Blue with black frame



BETA PRIVATE DINING CLUB by Sleth Architects
SE68SU Dining chair and SB38 Barstool



PLEASE WAIT to be SEATED Showroom
TOKIO Desk Lamp
EIERMANN2 Dining table, Navy Blue frame with Dark Blue linoleum table top
BONDI Chair, Turmeric Yellow
NOUVEAU PIN, Navy Blue
TUBBY TUBE stool

TINGBJERG LIBRARY AND CULTURE HOUSE by COBE architects
SE68SU with row connector



KJÆR ARCHITECTURE
EIERMANN1 Desk, black frame with black linoleum table top . SBG197R Office Chair

DESK VS. DINING TABLE

When you are to choose your Eiermann1 Desk, Eiermann2 Dining table or Eiermann3 Desk table , there is a few steps you need to go through, in order to get it right for yourself.

DO YOU NEED A DINING TABLE? OR DO YOU NEED A DESK?

They may look similar to you, but they are slightly different. The desk frame is designed for you to sit in the middle of the table and do your thing. The dining tables frames are made for several folks to sit all around. The visual difference is the position of the underneath cross bars. Check and you will see.

CHOOSE SIZE AND FRAME

- Choose the colour of your frame
- Choose your table top size and colour

You are all set.



EIERMANN1
DESK

EIERMANN2
DINING



EIERMANN3
DINING/MEETING



FILE UNDER POP Office
EIERMANN2 Dining table, white frame with white laminate table top · TOKIO Desk Lamp, grey



EIERMANN1
Desk



EIERMANN2
Dining

Sizes:

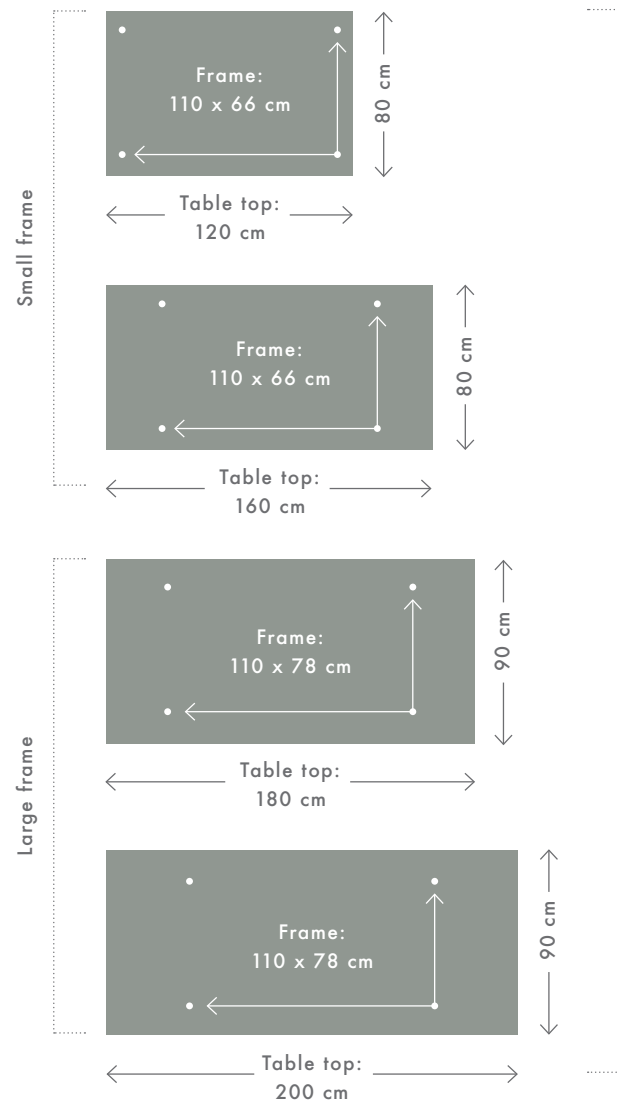

Sizes:

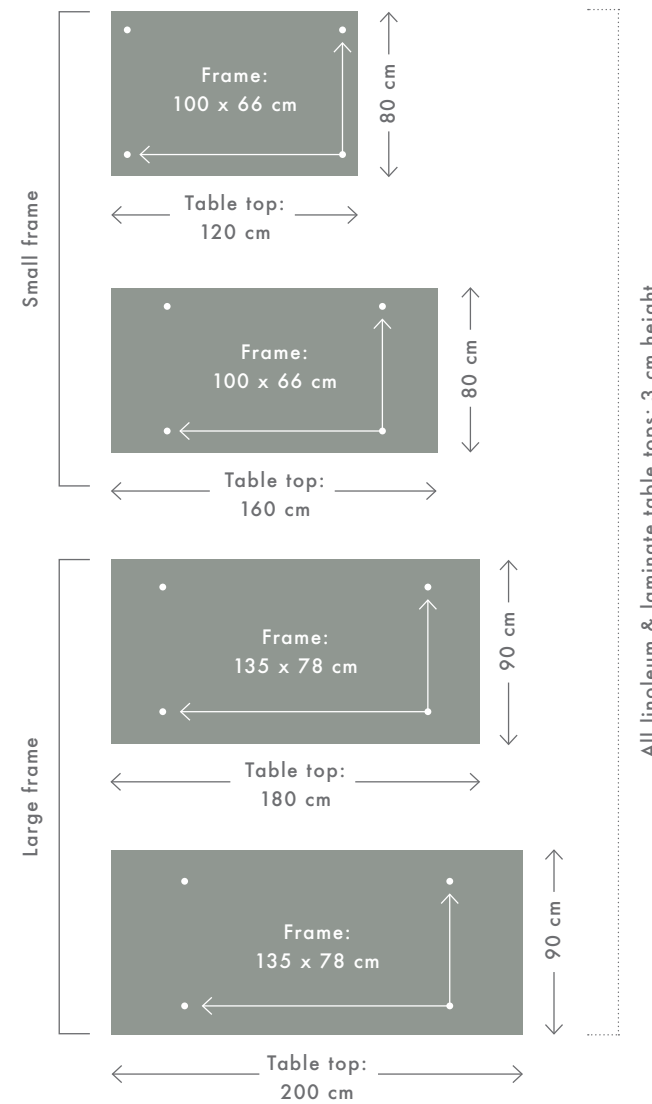

Adjustable frame - 5 different height:

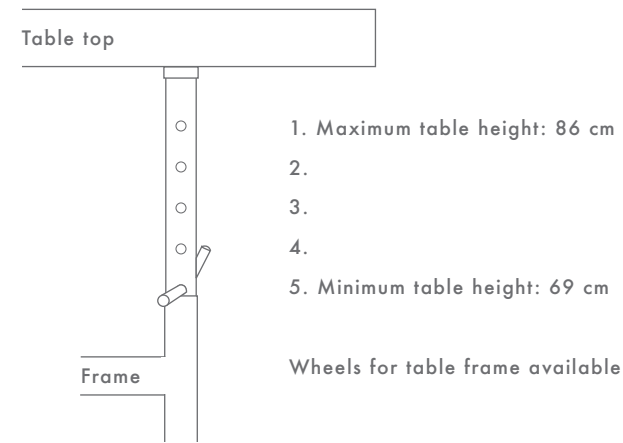
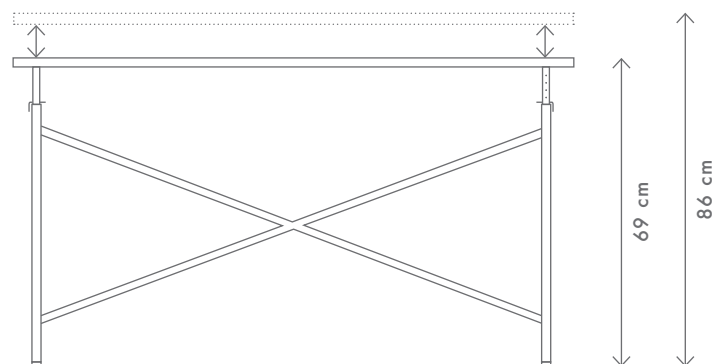

Table top material and color:

Linoleum with Oak edges



Table top material and color:

Composite



Frame material and color:

Steel

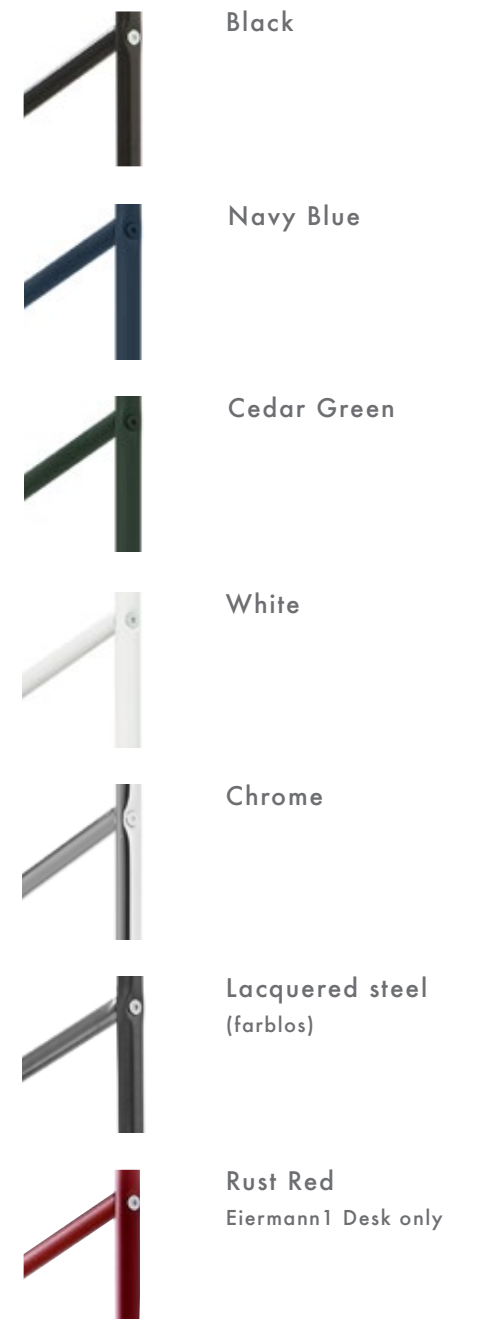

SE68 Classic



Stained black
with chrome frame

Beech
with black frame

Oak
with chrome frame

H: 79
Seat H: 46
W: 47
D: 50

Frame: chrome or black
Bespoke colour request
minimum 20 chairs

SBG197R Office Chair



Black

Oak
Beech

With armrests

H: 65-89
Seat H: 41-54
W: 54
D: 54

SE68 PLEASE WAIT to be SEATED colour range



Light Grey

Graphite

Cobalt

Jaipur

Blood
Orange

Yellow

All above is available with black frame or chrome frame

S197R 20



SE42



H: 78
Seat H: 46
W: 52,5
D: 51

SE18



H: 78
Seat H: 46
W: 52
D: 43

SE68 With armrests



Black or Natural Beech

SE68SU Stackable



Stacking:
8 chairs

Accessories:
Row linking device
Writing table
Chair trolley
Different glides

SB38 Barstool



H: 81
Seat H: 81
W: 46
D: 46

Available with black frame or chrome frame

S38 S/1 Stool



Stacking: 10 stools
H: 46
Seat H: 46
W: 38
D: 38

Available with black frame or chrome frame

Colours & Wood Veneers

Stained Colours

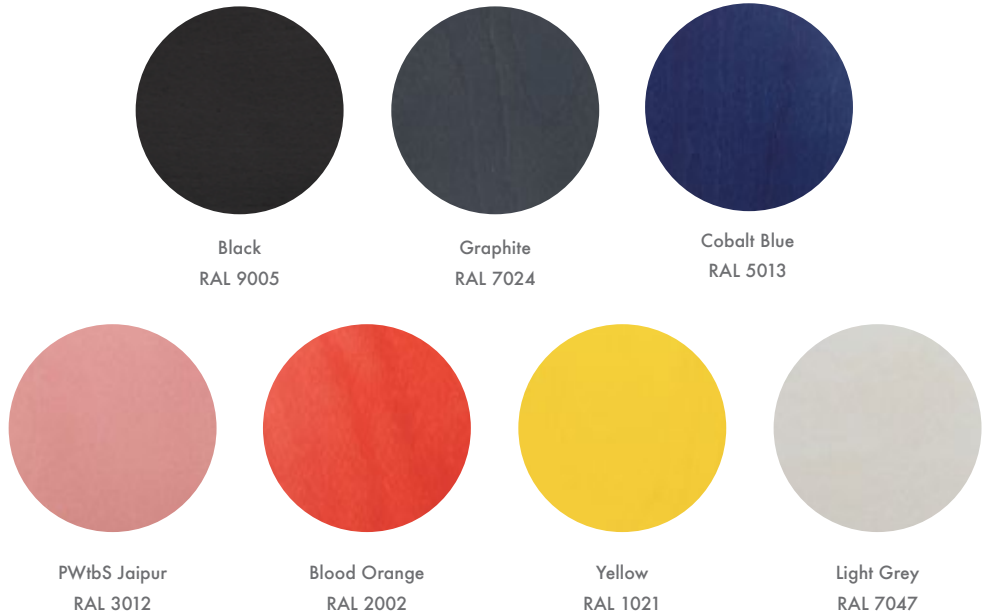

Lacquered Colours

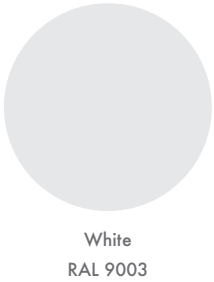

Wood Veneers



Fabric

Topia by Rohi

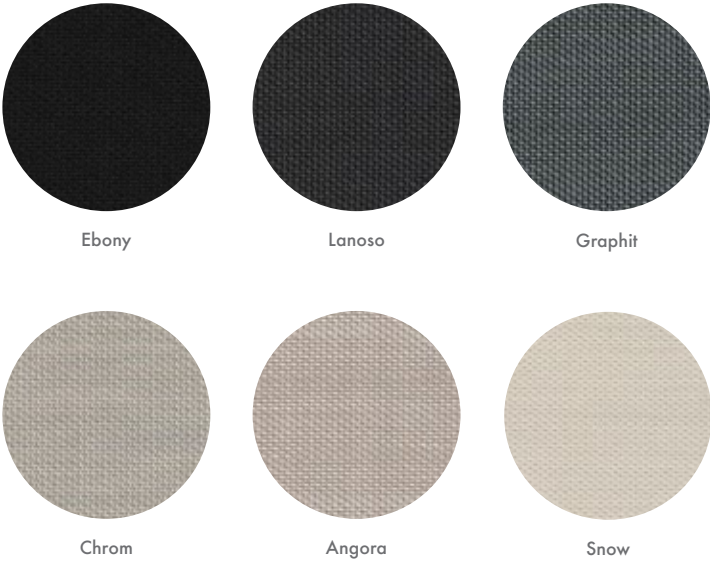

www.rohi.com/en/products/topia

Novum by Rohi



www.rohi.com/en/products/novum

King Flex by Fidivi

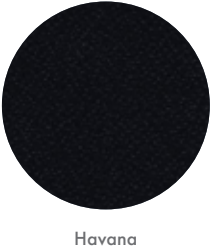

www.fidivi.com/en/fabrics/king-flex

Specifications

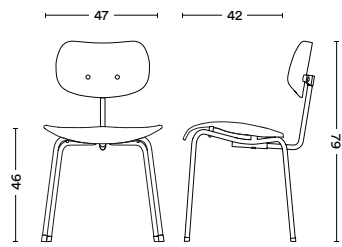

SE 68 Multipurpose Chair
Egon Eiermann, 1951
Material: 4-legged tubular steel frame (Ø 18 x 2 mm), moulded seat and backrest of laminated wood veneer
Stained colours: black, blue, PWtbS dark green, PWtbS Jaipur, PWtbS aubergine, PWtbS tumeric yellow, PWtbS navy blue
Lacquered colours: white
Weight: approx. 5 kg

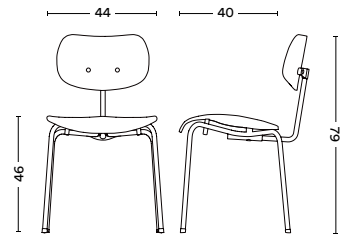

SE 68 SU Stackable Chair
Material: 4-legged tubular steel frame (Ø 18 x 2 mm), moulded seat and backrest of laminated wood veneer. The model is identical to SE 68 but with smaller seat and steeper leg placement to be stackable.
Stained colours: black, blue, PWtbS dark green, PWtbS Jaipur, PWtbS aubergine, PWtbS tumeric yellow, PWtbS navy blue
Lacquered colours: white
Weight: approx. 5 kg

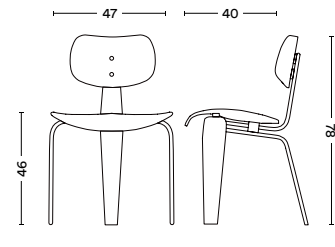

SE 42 3-Legged Chair
Egon Eiermann, 1949
Material: Curved wooden chair, 3-legged, with contoured wooden beech frame.
Stained colours: black, custom colours on request
Weight: approx. 5 kg

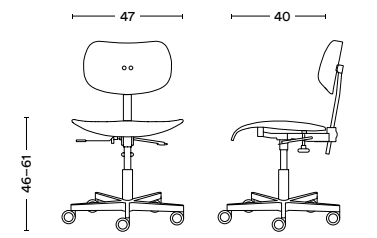

S 197 R20 Swivel Chair
Material: Swivel chair with aluminium frame. Moulded seat and backrest of laminated wood veneer.
Adjustments: Seat height adjustment, Seat tilt adjustment, back height adjustment
Stained colours: black, blue
Lacquered colours: white
Weight: approx. 10 kg

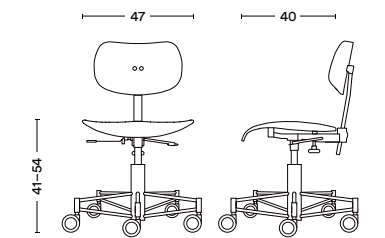

SBG 41 Swivel Chair
Material: Swivel chair with Brussels frame. Seat of laminated beech veneer. Backrest support moulded.
Adjustments: Seat height adjustment, back height adjustment
Stained colours: black, blue
Lacquered colours: white
Weight: approx. 9 kg

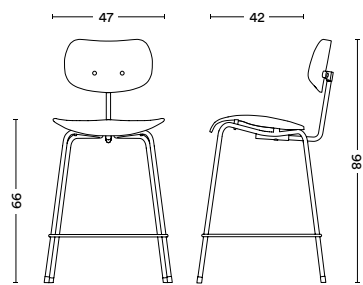

SE 68 Counter Chair
Material: 4-legged tubular steel frame with all-round foot ring (Ø 18 x 2 mm), moulded seat and backrest of laminated wood veneer
Stained colours: black, blue, PWtbS dark green, PWtbS Jaipur, PWtbS aubergine, PWtbS tumeric yellow, PWtbS navy blue
Lacquered colours: white, black
Weight: approx. 10 kg

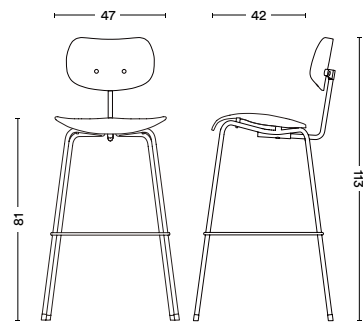

SE 68 Bar Chair
Material: 4-legged tubular steel frame with all-round foot ring (Ø 18 x 2 mm), moulded seat and backrest of laminated wood veneer
Stained colours: black, blue, PWtbS dark green, PWtbS Jaipur, PWtbS aubergine, PWtbS tumeric yellow, PWtbS navy blue
Lacquered colours: white
Weight: approx. 10 kg

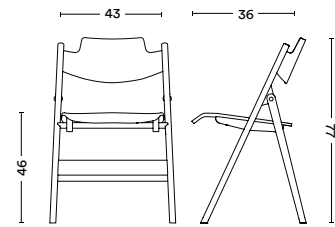

SE 18 Foldable Chair
Egon Eiermann, 1952
Material: Wooden folding chair with solid beech frame and tapered legs. Seat folds upwards when chair is folded. Horizontally stackable.
Stained colours: black, custom colours on request
Weight: approx. 5 kg

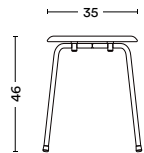

S 38/S1 Stackable Stool
Material: 4-legged stool with tubular steel frame (Ø 18 x 2 mm). Solid wood seat.
Stained colours: black
Lacquered colours: black
Weight: approx. 2.5 kg

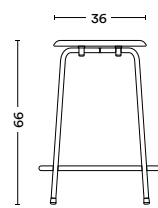

SB 38 Bar Chair (Counter)
Material: 4-legged stool with tubular steel frame (Ø 18 x 2 mm). Solid wood seat.
Stained colours: black
Lacquered colours: black
Weight: approx. 5 kg

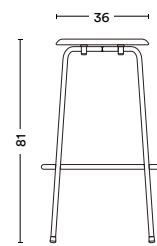

SB 38 Bar Chair
Material: 4-legged stool with tubular steel frame (Ø 18 x 2 mm). Solid wood seat.
Stained colours: black
Lacquered colours: black
Weight: approx. 5 kg

OFFICE & SHOWROOM

PLEASE WAIT to be SEATED A/S
Frederiksgade 1, 1st floor
1265 Copenhagen
Denmark

+45 3155 2600
sales@pleasewaittobeseated.dk

pleasewaittobeseated.com



Wilde + Spieth

